

Article number: 20479B816

Description: E+G Sensor holders - GN 479-B8-16

Measures

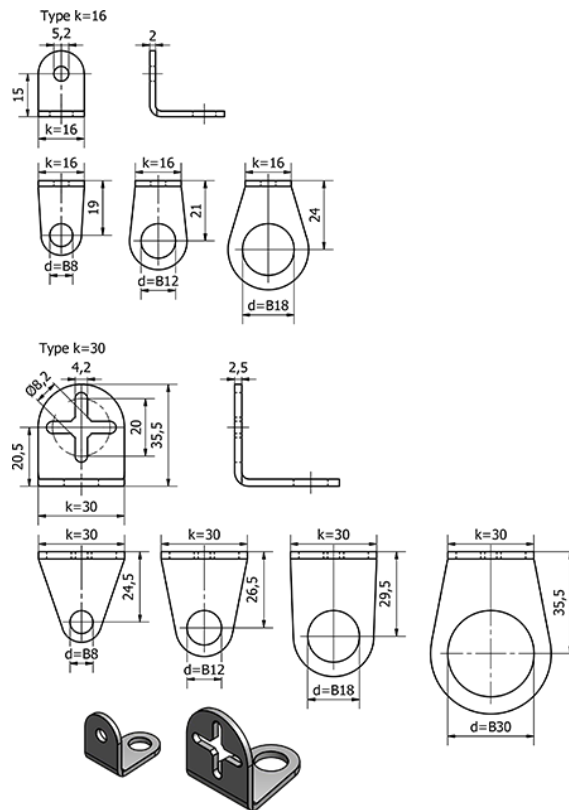

d = 8
k = 16
Weight (g) = 9